

Play&Work

Technical description

For 1.5-seater sofas and pouffes, right or left version is defined by the table or fixed writing tablet location from perspective of seated person.

For 1-seater module, right or left version is defined by the corner panel location from perspective of seated person.

SOFAS AND POUFFES

Product range and dimensions

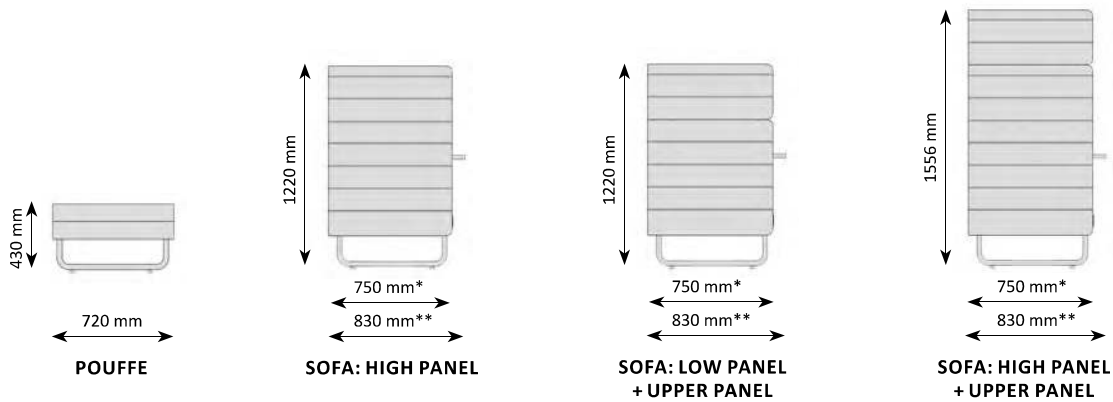

* Applicable to all sofas except 1.5 seater sofa with fixed writing tablet.
 ** Applicable to 1.5 seater sofa with fixed writing tablet.

Construction

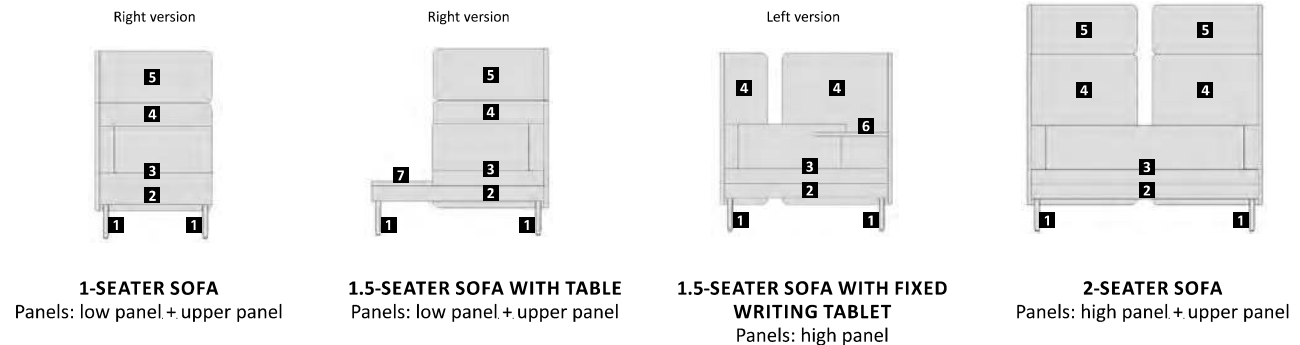

- 1** Base
- 2** Lower part of seat
- 3** Backrest, armrests and upper part of seat
- 4** Panels
- 5** Upper panels as an option
- 6** Writing tablet (for 1.5-seater sofa with fixed writing tablet)
- 7** Table (for 1.5-seater sofa with table)

Technical description

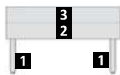

1-SEATER POUFFE

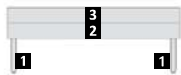

1.5-SEATER POUFFE

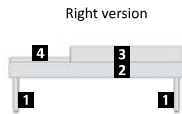

1.5-SEATER POUFFE WITH TABLE

- 1** Base
- 2** Lower part of seat
- 3** Upper part of seat
- 4** Table (for 1.5-seater pouffe with table)

Media port location:

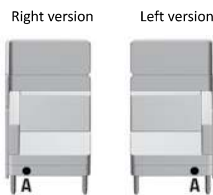

1-SEATER SOFA

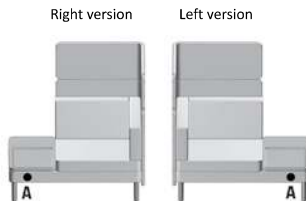

1.5-SEATER SOFA WITH TABLE

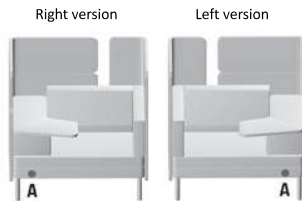

1.5-SEATER SOFA WITH FIXED WRITING TABLET

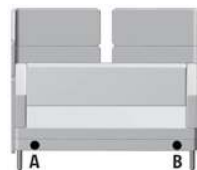

2-SEATER SOFA
Media ports in one or two locations



1-SEATER POUFFE

Media port only in one location in position A or B

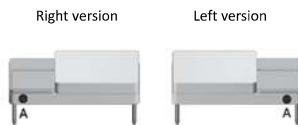

1.5-SEATER POUFFE WITH TABLE

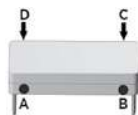

1.5-SEATER POUFFE

Media ports in one or two locations

AMERICAN DINER

Dimensions

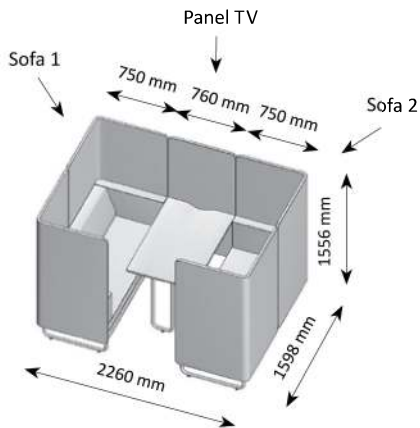

Media port positioning

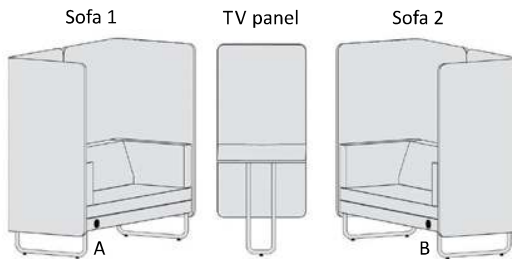

Media ports in one or two locations

Construction

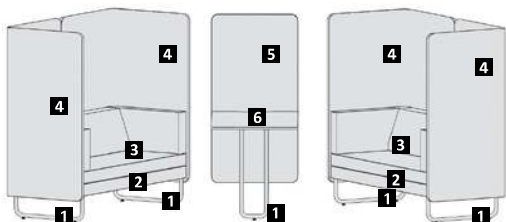

- 1** Base (Sofa 1, Sofa 2, TV panel)
- 2** Lower part of seat (Sofa 1, Sofa 2)
- 3** Backrest, armrests and upper part of seat (Sofa 1, Sofa 2)
- 4** Panels (Sofa 1, Sofa 2)
- 5** TV panel + vertical wire trunking when choosing TV holder and / or media port in table top
- 6** Table top

Technical description

SOFAS AND POUFFES

Base

U-legs – made of bent, steel tube, \varnothing 30mm, with levelling glides, available as standard. Finish options: Jet black (BL), White aluminium (WA), Traffic white (WT) or “Fashion collection” colours.

4-legs wooden – made of solid wood, \varnothing 40 mm, available as an option. Finish options: natural beech, stained beech in white or black colour, natural oak.

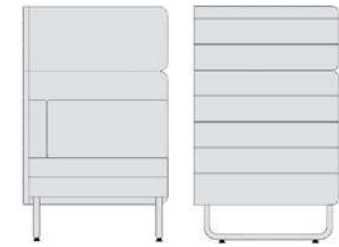

U-legs

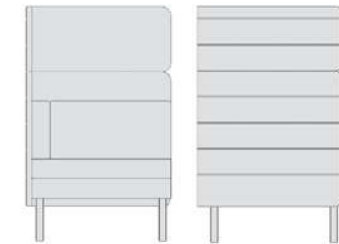

4-legs wooden

Lower part of seat Sofas and pouffes
Seat frame is made of wood covered with upholstery lined with foam. The height of finished lower seat part is 100 mm.

Upper part of seat Sofas and pouffes
Upper part of seat is made of foam, thickness 100 mm, density 50 kg/m³, upholstered and fixed to lower part of seat with velcro-type fixing.

Backrest and armrests Sofas
Backrest made of foam, density 24 kg/m³. Armrest made of foam, density 40 kg/m³. Upholstered and fixed to panels with velcro-type fixing. It is not recommended to remove the cushions.

Panels and upper panels Sofas
Panel structure is made of plywood covered with upholstery lined with foam, thickness 5 mm. Panel is assembled to back part of seat, total thickness is 30 mm.
Upper panels structure is made of plywood covered with upholstery lined with foam, thickness 5 mm.
Panels and upper panels are available with 3D horizontal stitching, distinctive feature of Play&Work system, visible on external part as standard or without stitching, as an option.



Example of upper panel use in 1.5-seater sofa with fixed writing tablet.

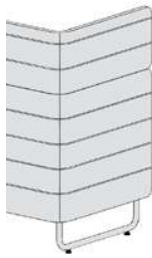

Panel and upper panel with stitching



Panel and upper panel without stitching

Upper panels are assembled to panels with connectors.

Panels and upper panels configurations:

- LUU – low panel + upper panel,
- H – high panel,
- HUU – high panel + upper panel.

Both low and high panels in configurations LUU and HUU are equipped with mechanisms with holes ready for clicking the connectors screwed to upper panels.

Total height of sofa with panel configuration

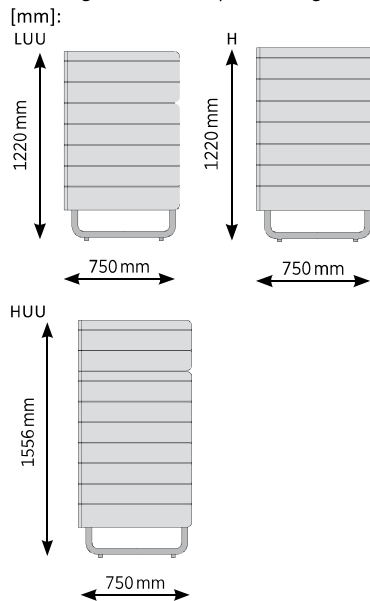
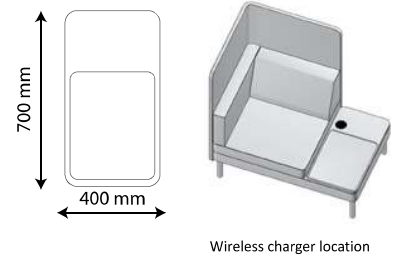

Table for 1.5-seater sofa and pouffes

Table is made of solid wood with shaped storage on the top surface. Total table top thickness 25 mm. It is assembled to the seat structure during the production process.

Finish options: beech, oak, black stained beech. MiniBatt Fr80 wireless charger with possibility of adapter, available for the table to be placed in cut out, both as an option.



Wireless charger location

Media ports

- Media port PIX, \varnothing 80 mm for sofas and pouffes, available as an option



- Wireless charger available as an option for the table in 1,5-seater sofa and 1,5-seater pouffe. Diameter 80 mm, power range 5W–10W. To be placed in cut out, positioning as per drawing.



Fixed writing tablet for 1.5-seater sofa

Writing tablet is made of melamine faced chipboard MFC (according to finishes), thickness 25 mm, fixed to sofa and not foldable, with storage for personal items under the tablet top. The front part of storage space is covered with upholstered foam. The writing tablet has 2 mm edge in glue technology defined as a standard for all melamine colours except for: NB Beech Bright, NH Maple, NJ Acacia Light, MP Platinum, MB White Grey, BI White, which are defined in laser technology as a standard.

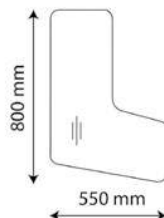

Technical description

Movable tablet

Accessory dedicated for sofas and pouffes. The movable tablet arm consists of U-shape bent metal tube, Ø 30 mm, connected with horizontal steel plate to be fixed to the seat frame. Tablet arm finish options: Jet black (BL), White aluminium (WA), Traffic white (WT) or "Fashion collection" colours.

It is recommended to choose matching metal colours of tablet arm and sofa or pouffe base. Table top is made of melamine faced chipboard (MFC), thickness 18 mm, rotates horizontally. Movable tablet is universal, can be fixed to any sofa or pouffe model except 1.5-seater sofa with fixed writing tablet.

Available in right and left version, defined from perspective of seated person.

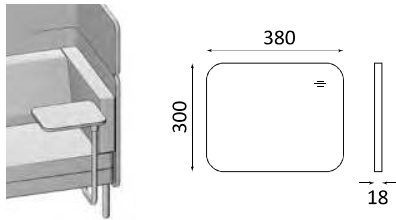

Examples of movable tablet positioning

Fixing of movable tablet according to assembly instruction ensures no collision with media port.

L – left movable tablet version
R – right movable tablet version

Pouffes

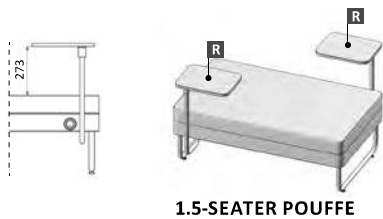

1.5-SEATER POUFFE

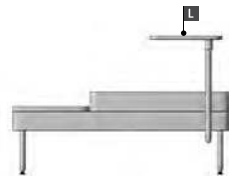

1.5-SEATER POUFFE with movable tablet
Right Version

Sofas

1-seater sofa

1,5- and 2-seater sofas

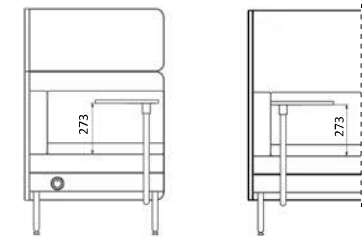

1,5-SEATER SOFA with movable tablet
Right version

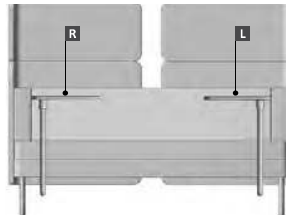

2-SEATER SOFA with movable tablet

Auxiliary table 1

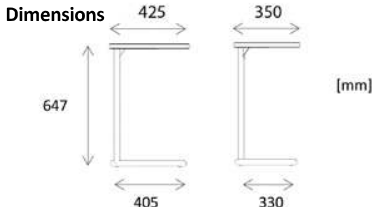
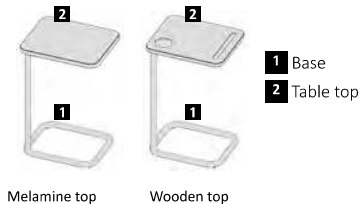

Base – the base is made of welded Ø 30 mm metal tubes powder-coated in Jet black (BL), White aluminium (WA), Traffic white (WT) or "Fashion collection" colours. The vertical tube ends in a horizontal plate to which the table top is fixed. Base is fitted with adjustable glides.

Table top – table top is made of melamine faced chipboard MFC, thickness 25 mm as standard. Table top has 2 mm edge in glue technology defined as a standard for all melamine colours except for: NB Beech Bright, NH Maple, NJ Acacia Light, MP Platinum, MB White Grey,

BI White, which are defined in laser technology as a standard. Table top made of solid wood beech or oak with cup and pen shaped organizer, thickness 23 mm, as an option. It is assembled to the base with connectors screwed into the plate welded to the base leg.

Technical description

AMERICAN DINER

Construction

4-seater unit with a table for organizing small meetings. Unit is a separate model, ordered as a complete product. It consists of two 2-seater sofas, a TV panel and a table.

Base

Sofas base: base consists of two "U" shape legs made of bent, steel tube, diameter 30mm, with levelling glides.

Table base: base consist of one "U" shape leg made of bent, steel tube, diameter 30mm, with levelling glides. Leg is terminated in metal plates for table top fixing. Sofas and table bases are always in the same colour.

Finish options: powder-coated in Jet black (BL), White aluminium (WA), Traffic white (WT) or "Fashion collection" colours.

Lower part of seat

Seat frame is made of wood covered with upholstery lined with foam. The height of finished lower seat part is 100 mm.

Backrest, armrests and upper part of seat

Upper part of seat is made of foam, thickness 100 mm, density 50 kg/m³, upholstered and fixed to lower part of seat with velcro-type fixing. Backrest and armrests are made of foam, density 24 kg/m³ and 40 kg/m³. Upholstered and fixed to panels with velcro-type fixing. It is not recommended to remove the cushions.

Panel

Panel structure is made of plywood, covered with upholstery lined with foam, thickness 5 mm. Panel is assembled to back part of seat with special connectors.

Total thickness of the panel: 30 mm.

Sofas panels configuration

– PHP - high panel plus

PHP configuration is available only for American Diner sofas.

Panel height of PHP configuration is the same as for high panel + upper panel configuration (HUU). PHP panels are available only in version without 3D stitching.

SOFAS

HUU

HIGH PANEL + UPPER PANEL



AMERICAN DINER

PHP

HIGH PANEL PLUS



3D STITCHING



NO 3D STITCHING



NO 3D STITCHING

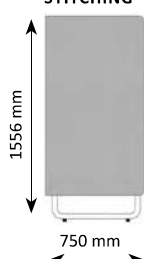

Configuration comparison: HUU appearing in the 2-seater sofa and PHP in the American Diner-unit sofas

Technical description

TV panel

TV panel is assembled to sofas panels with dedicated connectors. TV panel is available only in version without 3D stitching.

Table top

Melamine faced chipboard (MFC), thickness 25 mm, with 2 mm edge in glue technology as standard, for selected finishes laser edge as standard: NB Beech Bright, NH Maple, NJ Acacia Light, MP Platinum, MB White Grey, BI White. Table top to be fixed to TV panel and base with metal plates.

As standard, each table top has cut out for cabling placed next to TV panel.

Table top dimensions: 700 mm x 1100 mm, height: 770 mm.

Media ports

Sofas

Media port PIX, Ø 80 mm, available as an option



Table

Only one media port is possible in table top:

- Power Frame - 3 modules: 241 x 73mm



- PowerDot - 1 module, Ø 80mm



- Wireless charger miniBatt Fr80, Ø 80mm

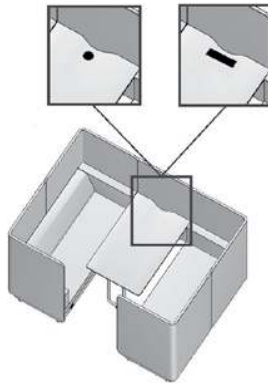

Media port positioning

TV holders

Fixed TV holder NBC1-F

Holder is intended for self-assembly with screws. Dedicated for 17 – 37" computer and TV screens, with a maximum load capacity of 18 kg.

VESA compliance:

- VESA 75 (hole distance 75 x 75 mm),
- VESA 100 (hole distance 100 x 100 mm),
- VESA 200 x 100 (hole distance 200 x 100 mm),
- VESA 200 (hole distance 200 x 200 mm).

Adjustable TV holder F120B

Holder is intended for self-assembly with screws. Dedicated for 17 – 27" computer and TV screens, with a maximum load capacity of 7 kg.

Adjustment range:

- tilt angle + 50° / - 35°,
- swivel up to 180°,
- minimum distance from the wall 85 mm,
- maximum distance from the wall 254 mm,
- pivot function.

VESA compliance:

- VESA 75 (hole distance 75 x 75 mm),
- VESA 100 (hole distance 100 x 100 mm).

Wire trunking

Available as standard when choosing following options:

- media port in table top – vertical, upholstered wire trunking, length 850 mm, assembly directly to table top,
- TV holder or combination of TV holder and media port in table top – vertical, upholstered wire trunking, length 1200 mm, assembly directly to TV panel with velcro-type fixing. Wire trunking has two cable entry points for TV screen and media port cabling.

Finish options: upholstery type and colour are the same as for TV panel.

Technical description

SOFAS AND POUFFES

Rules of upholsteries matching

Upholstery type is the same for each upholstered element, except for Price Group 4, within which upholstery type mixing is allowed.
Upholstery colour can be mixed in the following upholstery parts.

1. Sofa and pouffe

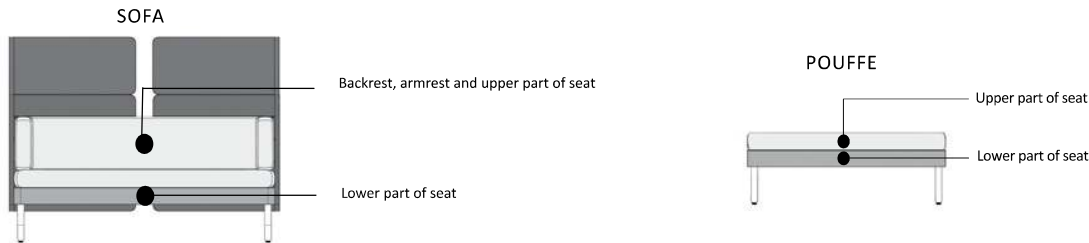

2. Panels – upholstery colour mix

Depending on sofa version one or two panels available. In case of two panels, version and upholstery colour mix to be configured separately.

Panel versions and upholstery colour mix sample configuration:

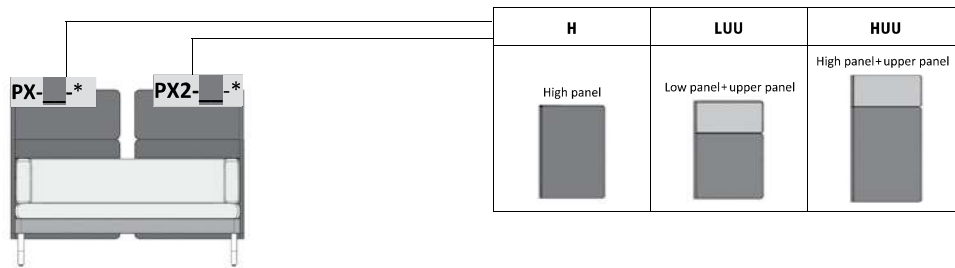

PX-H-**

example: PX-H-CUZ1E

PX-LUU-**/**

example: PX-LUU-CUZ1E/CUZ1P

PX-HUU-**/**

example: PX-HUU-CUZ1E/CUZ1P

* Upholstery colour code for each panel version.

** Panel finish.

*** Upper panel finish.

Upholstery colour mix: the same colour for low panels and the same for upper panels possible according to the drawing.

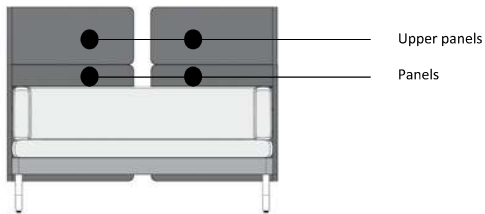

3. Panel ordering guidelines

Codes for panels differ depending on sofa version.

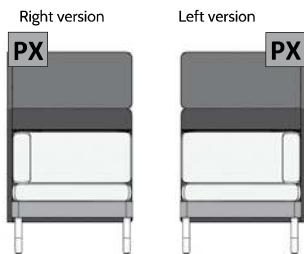

1-SEATER SOFA

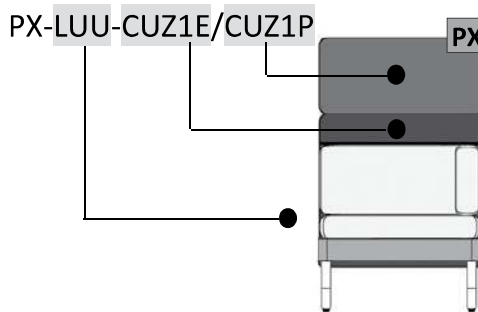

Technical description

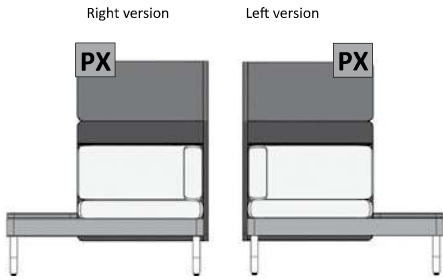

1,5-SEATER SOFA WITH TABLE

Sample order:

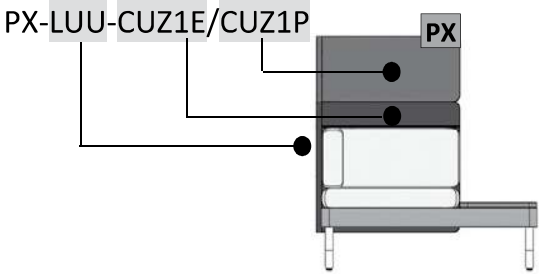

Sample order:

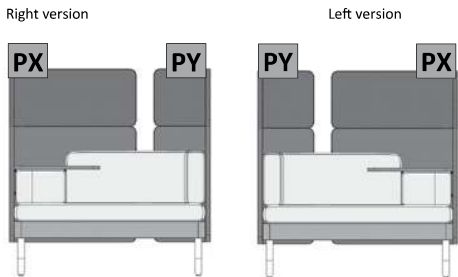

1,5-SEATER SOFA WITH FIXED WRITING TABLET

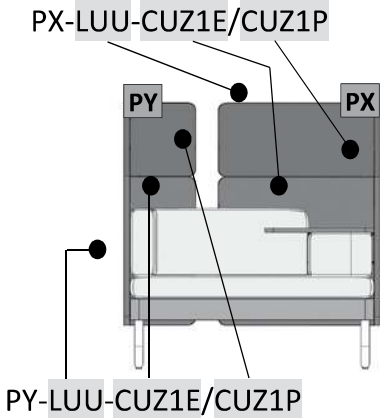

Sample order:

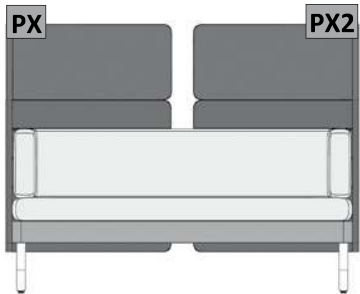

2 SEATER SOFA

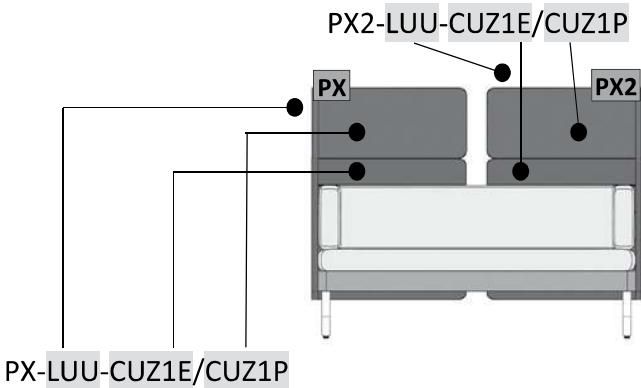

AMERICAN DINER

Rules of upholsteries matching

Upholstery type is the same for each upholstered element, except for Price Group 4, within which upholstery type mixing is allowed.

Upholstery colour can be mixed in the following upholstery parts:

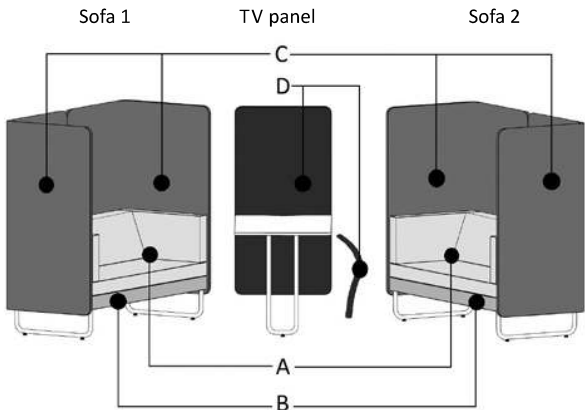

- A: Sofa 1 and Sofa 2: Upper part of seat, armrests and backrests
- B: Sofa 1 and Sofa 2: Lower part of seat
- C: Sofa 1 and Sofa 2: Panels
- D: TV panel and wire trunking included with media ports and TV handles