

Tepee

Technical description

Modular line of Tepee sofas and office walls enables to create arrangements that suit office areas of different functionalities. The system is perfect for arranging informal meeting places and relaxation zones as well as reception areas.

Tepee

The line consists of several sofa models that can be arranged freely. Free standing armchair without felt panel (FS1) is the only exception with no extension possibility. Some models are available with a table as an option. The table is fully integrated with the seat and based on the same structure which allows for reducing the number of legs. Tables also available as freestanding modules. Tepee sofas except FS1 model can be equipped with a felt panel available in three heights: 1226/1586/1766 mm which provides possibility of creating „room-in-room“ arrangements.

As an option, individual sofa models and tables can be equipped with electric ports: **Bachmann PIX** – electric port dedicated to Tepee sofas available in 2 configurations: 1 × 230V or 2xUSB, cable length 3 m, plastic in black colour only.

PIX 1–230V PIX 2–2xUSB



OE Electrics Pluto – electric port dedicated to Tepee tables available in two configurations: 3 × 230V or 2 × 230V + 2xUSB, in standard: CH13, FR, GB, GE, cable length 1,5 m, plastic in white colour only.

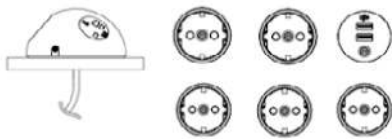

Maximum number of media ports and location available in configuration table. Socket type to be specified in the order.

Tepee line is complemented with:

- Tepee Wall
- Tepee Wall TV
- Tepee Work

Sofa construction

Sofas without panel

The structure of sofas is made of metal and wooden frame. Metal frame made of profiles and round tubes as part of legs, powder-coated in Jet black (BL), Traffic white (WT) or “Fashion collection” colours. Wooden solid beech part of legs finished in natural (1.007), black (1.043) or white stain (2.09S). Seat structure made of three-layer cut foam density 40 kg/m³, thickness 9,5–13 cm. Backrest made of cut foam density 21 kg/m³, thickness 9,5 cm.

Sofas with panel

The structure of sofas is made of metal and wooden frame. Metal frame made of profiles and

round tubes as part of legs powder-coated in Jet black (BL), Traffic white (WT) or “Fashion collection” colours. Wooden solid beech part of legs finished in natural (1.007), black (1.043) or white stain (2.09S). Seat structure made of three layer cut foam density 40 kg/m³, thickness 9,5–13 cm. Backrest made of cut foam density 21 kg/m³, thickness 9,5 cm. Sofas are integrated with thermoformed felt panel (100% polyester fiber with reduced fusibility subjected to a needling process) available in 3 heights: 1226, 1586 and 1766 mm and in two colours: dark grey (FC01) and light grey (FC02). The felt panel is fixed to sofa backrest with plywood profiles and additionally stabilized with solid beech wood connectors. Proper number of linking connectors to be ordered separately when sofa to sofa with panel connection is required. Please see section 7 and price list to calculate proper number of connectors.

Freestanding tables

Freestanding table is available with both sides HPL laminated table top and solid beech wooden frame. Metal frame made of profiles and round tubes as part of legs powder-coated in Jet black (BL), Traffic white (WT) or “Fashion collection” colours. Wooden solid beech part of legs finished in natural (1.007), black (1.043) or white stain (2.09S).

Tepee Wall

Tepee Walls are made of thermoformed felt (100% polyester fiber with reduced fusibility subjected to a needling process) with plywood profiles which stabilize the wall and the foot for each profile. Tepee Walls available as straight (SW), curved 90° (CW 90) or 120° (CW 120) versions for integration or freestanding. Tepee Walls available in 3 heights: 1226, 1586 and 1766 mm and in two colours: dark grey (FC01) and light grey (FC02). Felt panels may differ in shade in colour. Tepee Walls available as versions for integration or freestanding.

Tepee Wall for integration

Initial module – this module starts the arrangement for integration. External linking connectors included in the structure of initial module.

Middle module – this module to be connected on both sides with initial module, another middle or end module. Internal linking connectors included in the structure of middle module.

End module – this module always ends the arrangement to be connected with initial or middle module. Internal and external linking connectors included in this module.

Tepee Wall dedicated for integration cannot be a freestanding wall. To connect the walls for integration, internal linking connectors required. Each arrangement ends with external linking connectors. Both internal and external connectors are made of solid beech wood. Initial, end module and any number of middle modules enable to create the arrangement with adequate number of connectors and feet, narrow as standard, wide as an option. Connectors and feet included in the structure of Tepee Walls.

Tepee Wall freestanding module – equipped with proper number of external connectors made of solid beech wood and feet, Feet narrow as standard or wide as an option.

Feet options for Tepee Walls:

Narrow foot – made of metal powder-coated in Jet black (BL), Traffic white (WT) or “Fashion collection” colours.



Wide foot – made of metal powder-coated in Jet black (BL), Traffic white (WT) or “Fashion collection” colours, equipped with Velcro type fixing for soft floors or skidproof rubber for hard floors (both as standard) to increase stability of arrangement.

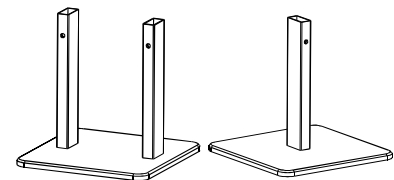

Foot dedicated to connect two Tepee Walls

Foot dedicated to external walls or freestanding walls

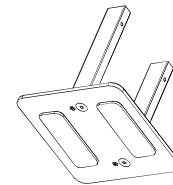

Velcro type fixing for soft floors or skidproof rubber for hard floors

Tepee Walls, both freestanding and for integration are equipped with proper number of internal and external connectors as standard and narrow feet as standard or wide feet as an option.

Tepee Walls with dedicated connectors and feet:

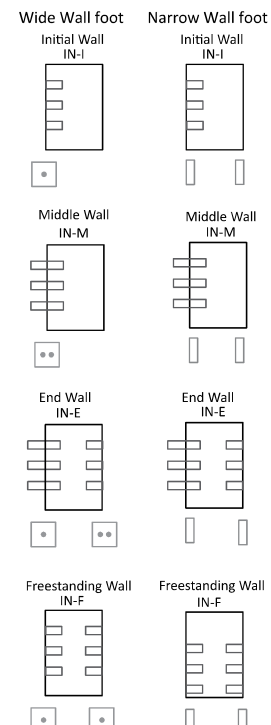

Technical description

Freestanding Tepee Wall SW with narrow and wide feet:

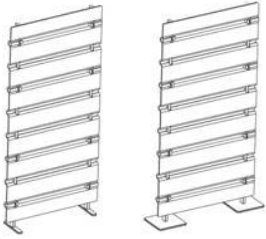

Narrow IN-F Wide IN-F

Tepee Wall TV

Tepee Wall TV dedicated for integration with two FS2 sofas with panels, height 1586 mm only. The Wall 80 × 1586 mm is made of thermoformed felt (100% polyester fiber with reduced fusibility subjected to a needling process) with integrated table. Table top is made of melamine faced chipboard MFC, thickness 25 mm and metal leg powder-coated in Jet black (BL), Traffic white (WT) or "Fashion collection" colours. Media ports or grommets available as an option. Two versions available: without TV holder as standard or with TV set (fixed NBC1 holder) as an option. TV monitor size is max 32".

Tepee Wall TV with FS2 sofas sample arrangement:

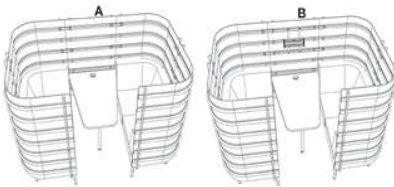

Fixed TV holder for B version.

Tepee Work

Tepee Work workstations dedicated for temporary work consist of Tepee Walls integrated with table top.

Two versions available:

Tepee Work SIT – panel height 1586 mm as standard or 1766 mm as an option, table top made of melamine faced chipboard MFC, thickness 25 mm, height 780 mm, width 1200 mm. Further connection with Tepee Wall and sofas with integrated panels available as an option. Grommets, media ports and cable management for table top available as an option.

Tepee Work SIT for integration

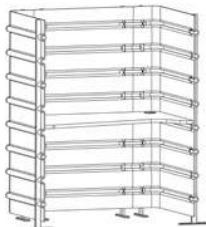

Tepee Work Stand – panel height 1766 mm as standard, table top height 1050 mm, table top made of melamine faced chipboard MFC, thickness 25 mm, width 800 or 1200 mm. Grommets, media ports and cable management for table top available as an option.



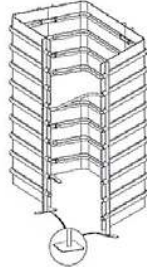

Tepee Work STAND, wide foot as an option:

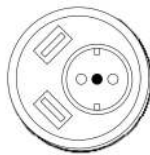

Tepee Work media port:

QE Electrics Pixel – electric port dedicated to Tepee Work table top available in configuration of 1 × 230V + 2XUSB, cable length 3m, plastic in black colour only.



-  GE
-  FR
-  GB
-  CH13

Feet options for Tepee Work:

- narrow foot made of metal powder-coated in Jet black (BL), Traffic white (WT) or "Fashion collection" colours as standard,
- wide foot made of metal powder-coated in Jet black (BL), Traffic white (WT) or "Fashion collection" colours as an option dedicated to external profiles to increase stability of initial walls of the arrangement, additionally equipped with Velcro type fixing for soft floors or skidproof rubber for hard floors (both as standard).

Connectors

Sofa connector – made of metal to connect sofa models with each other. The connectors are not visible when assembled to the frame under the seat.

The number of internal connectors needed for assembly of Tepee sofas:

$$2 \times (n - 1 - k)$$

n – the number of modules in a specific arrangement,

k – the sum of C90D modules in a specific arrangement.

Note: Number of connectors to be specified for each separate arrangement.



Panel connector – made of solid beech wood lacquered to connect panels made of thermoformed felt which stabilizes the panel additionally strengthened with beech plywood profile. The connectors are fixed to the panel with screws included in assembly set.

Types of connectors:

External connector – dedicated to end panels of the arrangements.

The number of connectors needed for assembly:

- for sofas with panel height 1226 mm – 2 pcs
- for sofas with panel height 1586/1766 mm – 4 pcs.



Internal connector – dedicated to connect panel to panel.

The number of connectors needed for assembly:

- for connecting 2 sofas with panel height 1226 mm – 1 pcs
- for connecting 2 sofas with panel height 1586/1766 mm – 2 pcs



The number of internal connectors needed for assembly Tepee sofas with panel:

n – 1 for sofas with panel height 1226 mm,

2 × (n-1) for sofas with panel height

1586/1766 mm,

n – the number of sofas panels in a specific arrangement.

Note: Number of connectors to be specified for each separate arrangement.

Connectors for freestanding sofas with panels and Tepee Walls included in assembly set.

Wire trunking

Horizontal wire trunking – dedicated to Tepee Work made of upholstery fixed directly to table top with plastic brackets. Two widths available: 800 and 1200 mm, height 120 mm.

Vertical wire trunking – dedicated to Tepee Work Sit – length 850 mm and Tepee Work Stand – length 1200 mm. It is made of upholstery with zip fixed directly to table top with plastic brackets.

Tepee Work SIT for integration – sample arrangements:

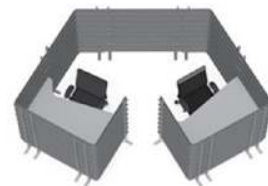

Technical description

Configuration rules

Connection of modules of the same panel height only. Sofa module with table and panel to be integrated with another sofa with panel only.

Tepee sofas with panel configuration

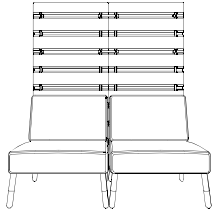

Correct

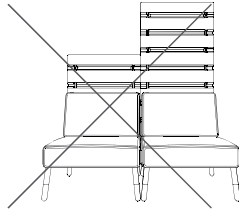

Incorrect

Tepee Walls configuration

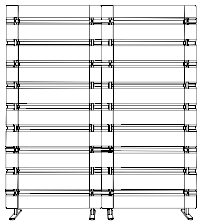

Correct

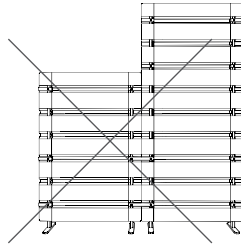

Incorrect

Tepee sofa module with table and panel to be integrated with another sofa with panel

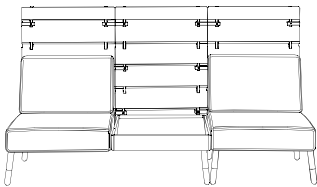



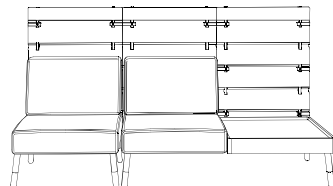

Correct



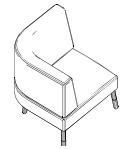
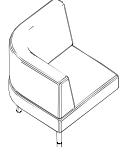

Incorrect

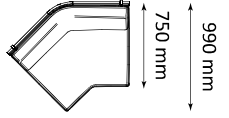
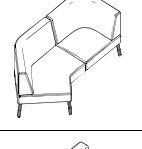
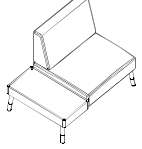
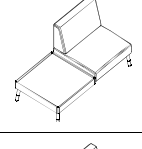
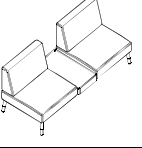
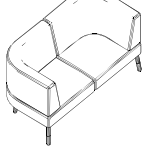
Dimensions

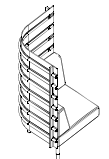
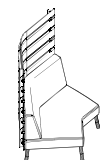
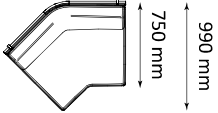
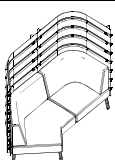
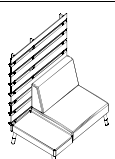
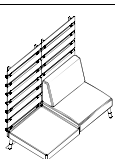
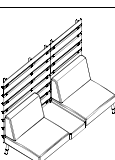
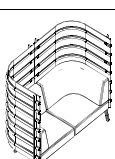

Model	Drawing	Seat height	Backrest height	Total height	Total width	Total depth	Table top height
FS1		420 mm	420 mm	840 mm	1026 mm	734 mm	
S1		420 mm	420 mm	840 mm	750 mm	750 mm	
S2		420 mm	420 mm	840 mm	1500 mm	750 mm	
C90 right and left version		420 mm	420 mm	840 mm	750 mm	750 mm	
C90D right and left version		420 mm	420 mm	840 mm	750 mm	750 mm	
C 135		420 mm	420 mm	840 mm	1110 mm		
C135 + 90 right and left version		420 mm	420 mm	840 mm	1860 mm	750 mm	
STS right and left version		420 mm	420 mm	840 mm	1125 mm	750 mm	350 mm
STB right and left version		420 mm	420 mm	840 mm	1500 mm	750 mm	350 mm
STC		420 mm	420 mm	840 mm	1875 mm	750 mm	350 mm
FS2		420 mm	420 mm	840 mm	1500 mm	750 mm	

Dimensions

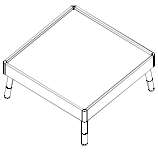
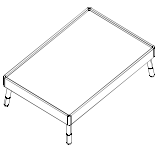
Model	Drawing	Seat height	Backrest height	Total height with panel	Total width	Total depth	Table top height
S1 with panel		420 mm	420 mm	1226 mm 1586 mm 1766 mm	750 mm	750 mm	
S2 with panel		420 mm	420 mm	1226 mm 1586 mm 1766 mm	1500 mm	750 mm	
C90 with panel right and left version		420 mm	420 mm	1226 mm 1586 mm 1766 mm	750 mm	750 mm	
C90D with panel right and left version		420 mm	420 mm	1226 mm 1586 mm 1766 mm	750 mm	750 mm	
C135 with panel		420 mm	420 mm	1226 mm 1586 mm 1766 mm	1110 mm		
C135 + 90 with panel right and left version		420 mm	420 mm	1226 mm 1586 mm 1766 mm	1860 mm	750 mm	
STS with panel right and left version		420 mm	420 mm	1226 mm 1586 mm 1766 mm	1125 mm	750 mm	350 mm
STB with panel right and left version		420 mm	420 mm	1226 mm 1586 mm 1766 mm	1500 mm	750 mm	350 mm
STC with panel		420 mm	420 mm	1226 mm 1586 mm 1766 mm	1875 mm	750 mm	350 mm
FS2 with panel		420 mm	420 mm	1226 mm 1586 mm 1766 mm	1500 mm	750 mm	

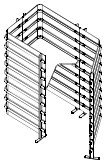
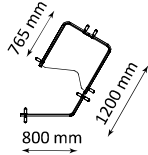
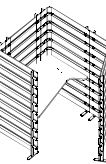
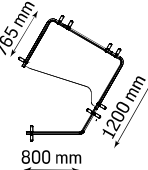
Tables				
Model	Drawing	Total height	Total width	Total depth
Tepee table 750 x 750		350 mm	750 mm	750 mm
Tepee table 1125 x 750		350 mm	1125 mm	750 mm

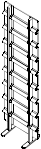
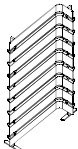
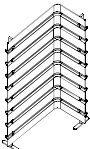
Work						
Model	Drawing	Total height	Total width	Table top width	Working surface height	Wing
Tepee Work Stand		1766 mm	800/1200 mm	1200 mm	1050 mm	
Tepee Work Sit		1586/1766 mm	1200 mm	800 mm	780 mm	

Office Panels				
Model	Drawing	Total height	Total width	Total depth
Tepee Office Wall SW		1226/ 1586/ 1766 mm	400/ 800/ 1200 mm	—
Tepee Office Wall SW CW90	 	1226/ 1586/ 1766 mm	800 mm	200/ 400 mm
Tepee Office Wall CW120		1226/ 1586/ 1766 mm	800 mm	400 mm