

Tapa

# Technical description

The line of Tapa pouffes has been designed to complement office spaces, reception areas and breakout zones. Their unique design adds an exceptional character to an interior, creating an attractive and comfortable informal meeting place.

## Modularity

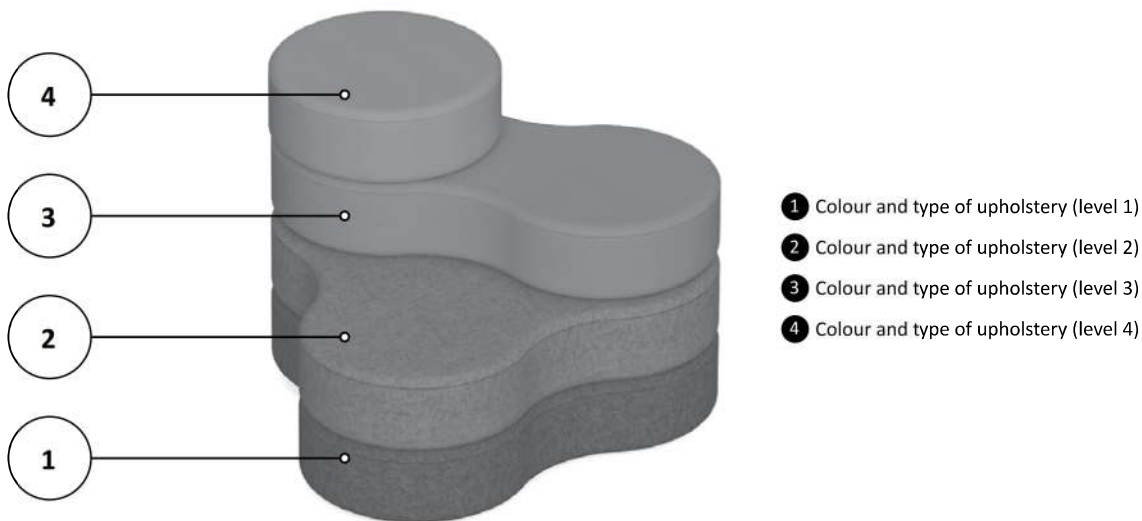
The product range comprises eleven types of pouffe – single-level pouffes: "O" type (three heights), "Y" type, "I" type, "Square O" type,

"Square I" type and "Square L" type as well as four-level modular pouffe: "N" type and "Square" type. Used as a single element, the pouffe performs the role of a mobile seat that complements a workplace and improves its comfort. They also allow for creating different arrangements which aid in designing an effective and comfortable meeting zone that facilitates information exchange. The users' comfort is ensured by foam of the proper density and with the right thickness.

## Note

The possibility to shade particular pouffe levels or to choose contrasting colours adds an additional aesthetically-pleasing effect to the whole arrangement.




## Sample order



TAPA POUFFE N4-I (W1090 D800 H620 ① | ② | ③ | ④ GRG1)



TAPA POUFFE N4-I (W1090 D800 H620 CUZ1E | CUZ1L | CUZ21 | CUZ28 GRG1)

Model	Description	
<b>N4-I – FOUR-LEVEL POUFFE (MODULAR)</b> 	Carcass: birch plywood (30 mm) + metal rotational mechanisms Glides: plastic, black colour Filling: polyurethane foam, styrofoam The pouffe has its axis of rotation at the short side. Axis of rotation in the picture.  Dimensions: 800 × 1090 mm Seat height: 620 mm	TAPA POUFFE N4-I (W1090 D800 H620 ①   ②   ③   ④ GRG1)
<b>N4-II – FOUR-LEVEL POUFFE (MODULAR)</b> 	Carcass: birch plywood (30 mm) + metal rotational mechanisms Glides: plastic, black colour Filling: polyurethane foam, styrofoam The pouffe has its axis of rotation at the long side. Axis of rotation in the picture.  Dimensions: 800 × 1090 mm Seat height: 620 mm	TAPA POUFFE N4-II (W1090 D800 H620 ①   ②   ③   ④ GRG1)
<b>O4 SQUARE – FOUR LEVEL POUFFE (MODULAR)</b> 	Carcass: plywood (30 mm) + metal rotational mechanisms Glides: plastic, black colour Filling: polyurethane foam, styrofoam. Axis of rotation in the picture.  Dimensions: 900 × 900 mm Seat height: 620 mm	TAPA POUFFE O4 SQUARE (W900 D900 H620 ①   ②   ③   ④ GRG1)










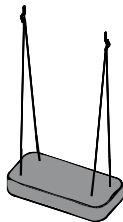

Model	Description
<b>TABLE</b> 	Tabletop: melamine (18 mm) Base: powder-coated metal  Dimensions: Ø 450 mm Height: 655 mm


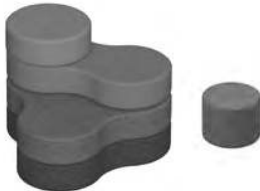
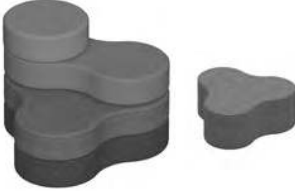


			Table top					
			Black	White	Cashmere	Kaisersberg Oak	Acacia light	Aragon oak
			CC	BI	NK	ML	NJ	NA
Base	Jet black	BL	•	—	—	•	•	•
	Traffic white	WT	—	•	—	—	—	—
	“Fashion Collection” colour	see finishes	—	—	•	•	•	•

# Tapa





Model	Description
<p><b>SINGLE-LEVEL POUFFE – "O" TYPE</b></p> 	<p>Filling: polyurethane foam, styrofoam</p> <p>Dimensions: ø 400 mm Seat height: 150 mm</p>
<p><b>SINGLE-LEVEL POUFFE – "O" TYPE</b></p> 	<p>Carcass: chipboard (18 mm) Glides: plastic, black colour Filling: polyurethane foam, styrofoam</p> <p>Dimensions: ø 400 mm Seat height: 170 mm</p>
<p><b>SINGLE-LEVEL POUFFE – "O" TYPE</b></p> 	<p>Carcass: chipboard (18 mm) Glides: plastic, black colour Filling: polyurethane foam, styrofoam</p> <p>Dimensions: Ø 400 mm Seat height: 320 mm</p>
<p><b>SINGLE-LEVEL POUFFE – "I" TYPE</b></p> 	<p>Glides: plastic, black colour Filling: polyurethane foam, styrofoam</p> <p>Dimensions: 800 x 400 mm Seat height: 150 mm</p>
<p><b>SINGLE-LEVEL POUFFE – "Y" TYPE</b></p> 	<p>Carcass: chipboard (18 mm) Glides: plastic, black colour Filling: polyurethane foam, styrofoam</p> <p>Dimensions: 800 x 745 mm Seat height: 320 mm</p>

Model	Description
<b>SINGLE-LEVEL POUFFE – POUFFE O SQUARE</b> 	Carcass: chipboard (18 mm) Glides: plastic, black colour Filling: polyurethane foam, styrofoam  Dimensions: 450 x 450 mm Seat height: 470 mm
<b>SINGLE-LEVEL POUFFE – POUFFE I SQUARE</b> 	Carcass: chipboard (18 mm) Glides: plastic, black colour Filling: polyurethane foam, styrofoam  Dimensions: 900 x 450 mm Seat height: 470 mm
<b>SINGLE-LEVEL POUFFE – POUFFE L SQUARE</b> 	Carcass: chipboard (18 mm) Glides: plastic, black colour Filling: polyurethane foam, styrofoam  Dimensions: 900 x 900 mm Seat height: 320 mm
<b>TAPA SWING SQUARE</b> 	Carcass: beech plywood (30 mm) Rope: black polypropylene, Ø 10 mm, length: 2 x 6000 mm, maximum swing height: 3000 mm Link: black metal Filling: polyurethane foam  Maximum swing load: 100 kg The set does not include mounting hooks. Preparing the ceiling and fixing the swing is at the responsibility of the customer or the general contractor. Swing assembly to fixing surface is at the responsibility of the customer or the general contractor. (swing is not suitable for suspended ceilings).  Dimensions: 900 x 450 mm Seat height: 150 mm
<b>TAPA SWING</b> 	Carcass: beech plywood (30 mm) Rope: black polypropylene, Ø 10 mm, length: 2 x 6000 mm, maximum swing height: 3000 mm Link: black metal Filling: polyurethane foam Maximum swing load: 100 kg The set does not include mounting hooks. Preparing the ceiling and fixing the swing is at the responsibility of the customer or the general contractor. Swing assembly to fixing surface is at the responsibility of the customer or the general contractor (swing is not suitable for suspended ceilings).  Dimensions: 800 x 400 mm Seat height: 150 mm






# Sample configurations

Model	Description	
<p><b>SAMPLE CONFIGURATION 1</b></p> 	<p>single-level pouffe "O" type + single level pouffe "Y" type.</p>	<p>TAPA POUFFE O (D1400 H320 ① GRG1)</p> <hr/> <p>TAPA POUFFE Y (W800 D745 H320 ① GRG1)</p>
<p><b>SAMPLE CONFIGURATION 2</b></p> 	<p>N4-I – four-level pouffe (modular) + single-level pouffe "O" type</p>	<p>TAPA POUFFE N4-I (W1090 D800 H620 ①   ②   ③   ④ GRG1)</p> <hr/> <p>TAPA POUFFE O (D1400 H320 ① GRG1)</p>
<p><b>SAMPLE CONFIGURATION 3</b></p> 	<p>N4-I – four-level pouffe (modular) + single-level pouffe "Y" type</p>	<p>TAPA POUFFE N4-I (W1090 D800 H620 ①   ②   ③   ④ GRG1)</p> <hr/> <p>TAPA POUFFE Y (W800 D745 H320 ① GRG1)</p>
<p><b>SAMPLE CONFIGURATION 4</b></p> 	<p>N4-II – four-level pouffe (modular) + single-level pouffe "O" type</p>	<p>TAPA POUFFE N4-II (W1090 D800 H620 ①   ②   ③   ④ GRG1)</p> <hr/> <p>TAPA POUFFE O (F1400 H320 ① GRG1)</p>
<p><b>SAMPLE CONFIGURATION 5</b></p> 	<p>N4-II – four-level pouffe (modular) + single-level pouffe "Y" type</p>	<p>TAPA POUFFE N4-II (W1090 D800 H620 ①   ②   ③   ④ GRG1)</p> <hr/> <p>TAPA POUFFE Y (W800 D745 H320 ① GRG1)</p>

# Sample configurations


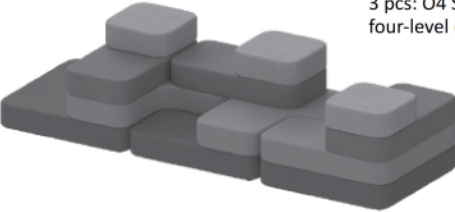
Model	Description	
<p><b>SAMPLE CONFIGURATION 6</b></p> 	<p>2 pcs: N4-II – four-level pouffe (modular)</p>	<p>TAPA POUFFE N4-II (W1090 D800 H620)  <span style="display: inline-block; border: 1px solid black; border-radius: 50%; padding: 2px;">1</span>   <span style="display: inline-block; border: 1px solid black; border-radius: 50%; padding: 2px;">2</span>   <span style="display: inline-block; border: 1px solid black; border-radius: 50%; padding: 2px;">3</span>   <span style="display: inline-block; border: 1px solid black; border-radius: 50%; padding: 2px;">4</span> GRG1)</p> <hr/> <p>TAPA POUFFE N4-II (W1090 D800 H620)  <span style="display: inline-block; border: 1px solid black; border-radius: 50%; padding: 2px;">1</span>   <span style="display: inline-block; border: 1px solid black; border-radius: 50%; padding: 2px;">2</span>   <span style="display: inline-block; border: 1px solid black; border-radius: 50%; padding: 2px;">3</span>   <span style="display: inline-block; border: 1px solid black; border-radius: 50%; padding: 2px;">4</span> GRG1)</p>
<p><b>SAMPLE CONFIGURATION 7</b></p> 	<p>N4-I four-level pouffe (modular) +  N4-II four level pouffe (modular)</p>	<p>TAPA POUFFE N4-I (W1090 D800 H620)  <span style="display: inline-block; border: 1px solid black; border-radius: 50%; padding: 2px;">1</span>   <span style="display: inline-block; border: 1px solid black; border-radius: 50%; padding: 2px;">2</span>   <span style="display: inline-block; border: 1px solid black; border-radius: 50%; padding: 2px;">3</span>   <span style="display: inline-block; border: 1px solid black; border-radius: 50%; padding: 2px;">4</span> GRG1)</p> <hr/> <p>TAPA POUFFE N4-II (W1090 D800 H620)  <span style="display: inline-block; border: 1px solid black; border-radius: 50%; padding: 2px;">1</span>   <span style="display: inline-block; border: 1px solid black; border-radius: 50%; padding: 2px;">2</span>   <span style="display: inline-block; border: 1px solid black; border-radius: 50%; padding: 2px;">3</span>   <span style="display: inline-block; border: 1px solid black; border-radius: 50%; padding: 2px;">4</span> GRG1)</p>
<p><b>SAMPLE CONFIGURATION 8</b></p> 	<p>3 pcs: N4-I – four-level pouffe (modular)</p>	<p>TAPA POUFFE N4-I (W1090 D800 H620)  <span style="display: inline-block; border: 1px solid black; border-radius: 50%; padding: 2px;">1</span>   <span style="display: inline-block; border: 1px solid black; border-radius: 50%; padding: 2px;">2</span>   <span style="display: inline-block; border: 1px solid black; border-radius: 50%; padding: 2px;">3</span>   <span style="display: inline-block; border: 1px solid black; border-radius: 50%; padding: 2px;">4</span> GRG1)</p> <hr/> <p>TAPA POUFFE N4-I (W1090 D800 H620)  <span style="display: inline-block; border: 1px solid black; border-radius: 50%; padding: 2px;">1</span>   <span style="display: inline-block; border: 1px solid black; border-radius: 50%; padding: 2px;">2</span>   <span style="display: inline-block; border: 1px solid black; border-radius: 50%; padding: 2px;">3</span>   <span style="display: inline-block; border: 1px solid black; border-radius: 50%; padding: 2px;">4</span> GRG1)</p> <hr/> <p>TAPA POUFFE N4-I (W1090 D800 H620)  <span style="display: inline-block; border: 1px solid black; border-radius: 50%; padding: 2px;">1</span>   <span style="display: inline-block; border: 1px solid black; border-radius: 50%; padding: 2px;">2</span>   <span style="display: inline-block; border: 1px solid black; border-radius: 50%; padding: 2px;">3</span>   <span style="display: inline-block; border: 1px solid black; border-radius: 50%; padding: 2px;">4</span> GRG1)</p>
<p><b>SAMPLE CONFIGURATION 9</b></p> 	<p>4 pcs: N4-II – four-level pouffe (modular)</p>	<p>TAPA POUFFE N4-II (W1090 D800 H620)  <span style="display: inline-block; border: 1px solid black; border-radius: 50%; padding: 2px;">1</span>   <span style="display: inline-block; border: 1px solid black; border-radius: 50%; padding: 2px;">2</span>   <span style="display: inline-block; border: 1px solid black; border-radius: 50%; padding: 2px;">3</span>   <span style="display: inline-block; border: 1px solid black; border-radius: 50%; padding: 2px;">4</span> GRG1)</p> <hr/> <p>TAPA POUFFE N4-II (W1090 D800 H620)  <span style="display: inline-block; border: 1px solid black; border-radius: 50%; padding: 2px;">1</span>   <span style="display: inline-block; border: 1px solid black; border-radius: 50%; padding: 2px;">2</span>   <span style="display: inline-block; border: 1px solid black; border-radius: 50%; padding: 2px;">3</span>   <span style="display: inline-block; border: 1px solid black; border-radius: 50%; padding: 2px;">4</span> GRG1)</p> <hr/> <p>TAPA POUFFE N4-II (W1090 D800 H620)  <span style="display: inline-block; border: 1px solid black; border-radius: 50%; padding: 2px;">1</span>   <span style="display: inline-block; border: 1px solid black; border-radius: 50%; padding: 2px;">2</span>   <span style="display: inline-block; border: 1px solid black; border-radius: 50%; padding: 2px;">3</span>   <span style="display: inline-block; border: 1px solid black; border-radius: 50%; padding: 2px;">4</span> GRG1)</p> <hr/> <p>TAPA POUFFE N4-II (W1090 D800 H620)  <span style="display: inline-block; border: 1px solid black; border-radius: 50%; padding: 2px;">1</span>   <span style="display: inline-block; border: 1px solid black; border-radius: 50%; padding: 2px;">2</span>   <span style="display: inline-block; border: 1px solid black; border-radius: 50%; padding: 2px;">3</span>   <span style="display: inline-block; border: 1px solid black; border-radius: 50%; padding: 2px;">4</span> GRG1)</p>

# Sample configurations

Model	Description	
<b>SAMPLE CONFIGURATION 10</b>  	Single-level pouffe O SQUARE type + single-level pouffe – L SQUARE type	TAPA POUFFE O SQUARE (W450 D450 H470 ① GRG1)
		TAPA POUFFE L SQUARE (W900 D900 H320 ① GRG1)
<b>SAMPLE CONFIGURATION 11</b>  	Single-level pouffe – I SQUARE type + single-level pouffe – L SQUARE type	TAPA POUFFE I SQUARE (W900 D450 H47 ① GRG1)
		TAPA POUFFE L SQUARE (W900 D900 H320 ① GRG1)
<b>SAMPLE CONFIGURATION 12</b>  	O4 SQUARE – four four-level (modular) + single-level pouffe O SQUARE type	TAPA POUFF O4 SQUARE (W1090 D900 H620 ①   ②   ③   ④ GRG1)
		TAPA POUFFE O SQUARE (W450 D450 H470 ① GRG1)
<b>SAMPLE CONFIGURATION 13</b>  	O4SQUARE – four-level (modular) + single-level pouffe – I SQUARE type	TAPA POUFF O4 SQUARE (W1090 D900 H620 ①   ②   ③   ④ GRG1)
		TAPA POUFFE I SQUARE (W900 D450 H470 ① GRG1)
<b>SAMPLE CONFIGURATION 14</b>  	O4 SQUARE – four-level (modular) + single-level pouffe – L SQUARE type	TAPA POUFF O4 SQUARE (W1090 D900 H620 ①   ②   ③   ④ GRG1)
		TAPA POUFFE L SQUARE (W900 D900 H320 ① GRG1)



# Sample configurations

Model	Description	
<p><b>SAMPLE CONFIGURATION 15</b></p> 	<p>2 pcs: O4 SQUARE – four-level pouffe (modular)</p>	<p>TAPA POUFF O4SQUARE (W1090 D900 H620 1   2   3   4 GRG1)</p> <hr/> <p>TAPA POUFF O4 SQUARE (W1090 D900 H620 1   2   3   4 GRG1)</p>
<p><b>SAMPLE CONFIGURATION 16</b></p> 	<p>3 pcs: O4 SQUARE – four-level (modular)</p>	<p>TAPA POUFF O4SQUARE (W1090 D900 H620 1   2   3   4 GRG1)</p> <hr/> <p>TAPA POUFF O4 SQUARE (W1090 D900 H620 1   2   3   4 GRG1)</p> <hr/> <p>TAPA POUFF O4 SQUARE (W1090 D900 H620 1   2   3   4 GRG1)</p>